

TransEnd® – 25

MEDIUM DUTY FOR DISTRIBUTION APPLICATIONS



FEATURES AND BENEFITS

- Listed to UL 1449 4th Edition for a Type 2 SPD application.
- Protects facilities and equipment against the harmful effects of lightning strikes and internally generated electrical transients.
- Includes pre-wired pigtail conductors to streamline installation.
- Features internal copper bus conduction path to minimize system impedances, lowering clamping voltage and increasing protection.

AVAILABLE CONFIGURATIONS

Model Number	Voltage	Configuration
XN25-120/240-2G	120/240V	1-Phase, 3-Wire + Ground
XN25-120/208-3GY	120/208V	3-Phase Wye, 4-Wire + Ground
XN25-220/380-3GY	220/380V	3-Phase Wye, 4-Wire + Ground
XN25-120/240-3GHD	120/240V	3-Phase High-Leg Delta, 4-Wire + Ground
XN25-277/480-3GY	277/480V	3-Phase Wye, 4-Wire + Ground
XN25-240-3DG	240V	3-Phase, 3-Wire + Ground
XN25-380-3DG	380V	3-Phase, 3-Wire + Ground
XN25-480-3DG	480V	3-Phase, 3-Wire + Ground

Warranty

5-years

Available Option

Dry Form "C" Relay Contacts Add suffix -FC

Stand Alone Options (To be ordered as a Separate Item)

Option A

XN Metallic Conduit Kit Metallic conduit installation kit has a 3/4" (.019 m) x 3" (.076 m) metallic nipple and all associated hardware required to complete the TransEnd installation

Option B

XN Plastic Conduit Kit Flexible plastic conduit installation kit, including 18" (.457 m) flexible conduit and all associated hardware required to complete the TransEnd installation

EMI/RFI Filter Attenuation

Max. Attenuation Frequency 50dB @ 100kHz

PRODUCT SPECIFICATIONS

Electrical

Maximum Surge Current Rating	50kA per phase, 25kA per mode
Nominal Discharge Current Rating (I-n)	20kA
Operating Frequency	47–63Hz
Connection Methods	Parallel to Load (shunt) 24" #10AWG wires Through 20A (max) breaker
Modes of Protection	L-N, L-G, N-G, L-L
Fault Rating (SCCR)	65kAIC – upstream over-current protection device (breaker or fuse required)
Response Time	Less than 1 nanosecond (one per phase)
Standard Monitoring	LED Status Indicator lights

Mechanical

Weight	12.7 lbs. (5.8 kg)
Enclosure Type	NEMA 4X fiberglass-reinforced polyester (FRP) surface-mount, non-removable cover
Installation Location	Indoor/Outdoor
Mounting Methods	Dual Mounting Flanges
Operating Environment	-40° to +140°F (-40° to +60°C)
Altitude	Up to 16,400 ft. (5000 m)
Product Design	No internal fusing

Regulatory

UL 1449 4th Edition Type	Type 2
UL 1283	Yes
IEEE C62.41.1, .2, C62.45	Yes
Listed By	UL

TRANSEND 25 PERFORMANCE DATA

Model Number	Voltage Configuration	Protection Mode	MCOV	UL 1449 4th Edition 6kV, 3kA VPR
XN25-120/240-2G	1S240	L-L	300V	1000V
		L-N	150V	600V
		L-G	150V	600V
		N-G	150V	600V
XN25-120/208-3GY	3Y208	L-L	300V	1000V
		L-N	150V	600V
		L-G	150V	600V
		N-G	150V	600V
XN25-220/380-3GY	3Y380	L-L	550V	1500V
		L-N	275V	900V
		L-G	275V	900V
		N-G	275V	900V
XN25-277/480-3GY	3Y480	L-L	552V	1800V
		L-N	320V	900V
		L-G	320V	1000V
		N-G	320V	1000V
XN25-120/240-3GHD	3H240	L-L	300V	1000V
		L-N	150V	600V
		L-G	150V	600V
		N-G	150V	600V
		H-L	425V	1500V
		H-N	275V	900V
XN25-240-3DG	3D240	L-L	275V	1000V
		L-G	550V	900V
XN25-380-3DG	3D380	L-L	550V	1800V
		L-G	400V	1500V
XN25-480-3DG	3D480	L-L	640V	1800V
		L-G	550V	1800V

All TransEnd® systems' Voltage Protection Ratings (VPRs) are peak values taken at the 90° point on the sine wave. Ring Wave values are taken at the 180° point on the sine wave. All data collection is in compliance with testing and evaluation procedures as outlined in ANSI/IEEE C62.45

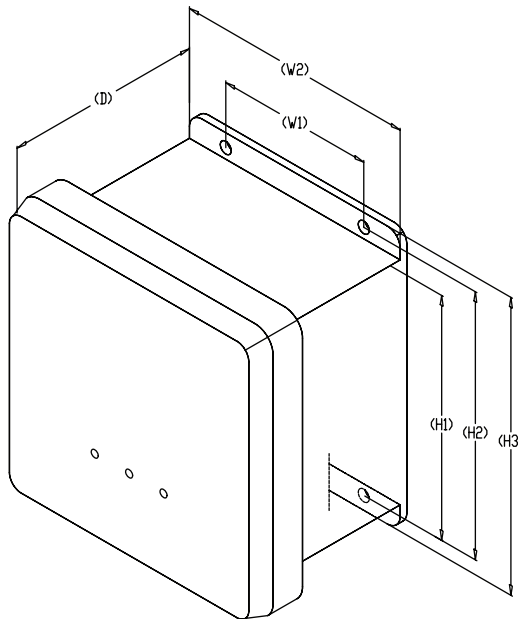

DIMENSIONS

Dim	Inches (mm)
H1	6.17 (156.7)
H2	6.75 (171.5)
H3	7.50 (190.4)
W1	4.01 (101.9)
W2	6.12 (155.4)
D	5.01 (127.5)